

Preservation As Provocation: Castle Pinckney

FUNDAMENTALS VS TYPOLOGY

History has a great effect on all professions. This influence manifests itself as a foundation for design. “The past is not just that which we know, it is that which we use, in a variety of ways, in the making of new work....”¹. We most often see history organized in the form of typologies while “despite the diversity of our culture there are still roots of this kind which allow us to speak of the idea of a library, a museum, a city hall or a house”². Typologies become the current framework for which all modern architecture is based. They are continuously developed, and act as an organizational representation of our understanding and thoughts of architectural history.

Typology, however, falls short at a smaller scale. What do we call the components that make up actual typology? How do we reference history at this scale?

To introduce a smaller scale of typology, we can look at the theme of Rem Koolhaas’ 2014 Venice Biennale, “Fundamentals.” While this theme is rather undefined until the opening of the biennale, it is evident that he is suggesting a system for classification. Like a study of typology, Koolhaas wants to “take a fresh look at the fundamental elements of architecture - used by any architect, anywhere, anytime....”³ Fundamentals, like typology, are a culmination of our understanding of the history, and at the correct scale, can be implemented in describing the techniques used in our proposal for Castle Pinckney: Preservation as Provocation Competition.

Stairs, doors, floors, ceilings, walls, lights, etc, are all examples of fundamentals of architecture that are manipulated to serve various programs. As a competition with preservation as the focus, fundamentals, rather than building typology, more closely reflect the scale of intervention aimed for the island.

CONCEPT

Located in Charleston, South Carolina, the competition challenges us to “explore the issues of access, the relationship between preservation and design, off grid energy consumption, water management, land use, and habitat protection”⁴. With this in mind, our proposal aims to revitalize the site both socially and environmentally.

More likely than not, the balance of preservation and design leans towards design and demands a large intervention, one that is typological. We propose to drastically revitalize the site in an extreme, but also cautious way. While the footprint of the intervention may seem extravagant, the lack of a building enclosure and porosity of the floor makes the intervention almost invisible in plan. By doing this, the design functions have all the elements of a public building, but without the added demands and impact. This allows a certain level of transparency where the structure is able to integrate with the island in an unobtrusive way. A steel grated platform becomes the overwhelming fundamental used in the project, with additional fundamentals attached. The low-lying platform is virtually invisible to see up close, and even in observation from a distance, thus retaining the island's undisturbed view.

IDEAS

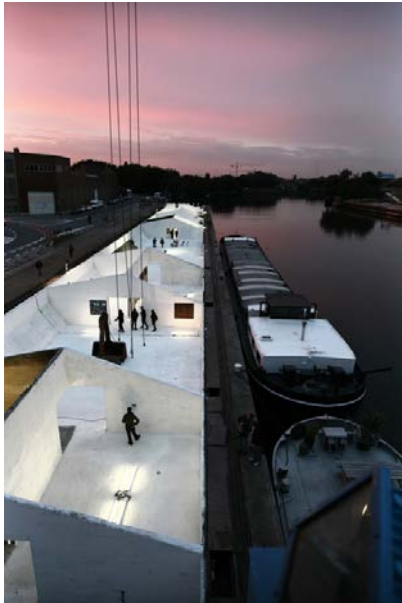

⁵Rotor: a building without its full enclosure can create an extremely successful public space. Visitors are able to appreciate the building as something between a public building and public square.



⁶Seattle Public Library: we see the appropriation of space in this image when visitors use the study desks as a place to play chess rather than read. This form of appropriation is what we want to achieve while also allowing the furniture to transform and better serve the visitors needs.



⁷The idea of the skeleton is implemented in the selection of the steel grate as the primary fundamental element used for all flooring. Like scaffolding, it is extremely transparent and effective in serving its primary function of being structural

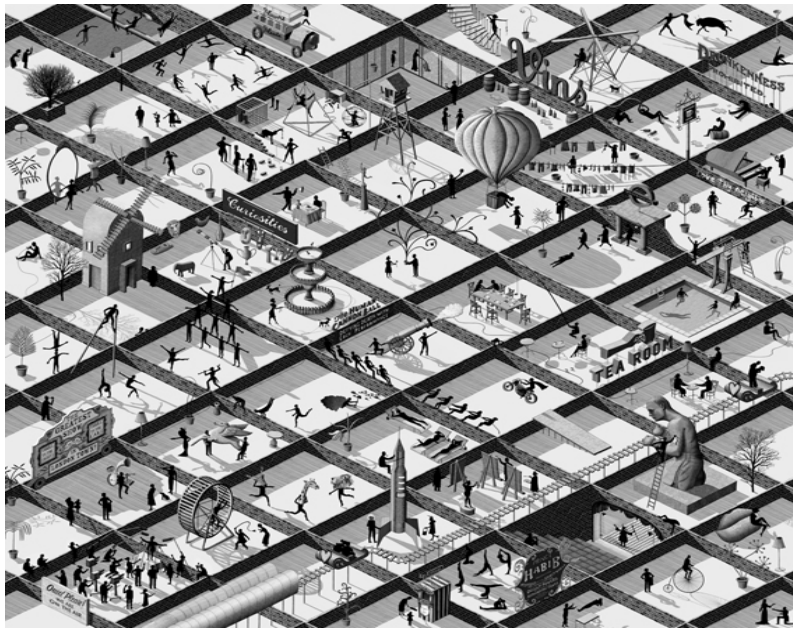

⁹Similar to the image from Rotor, this image displays the projects ambition of a public space with various uses and no enclosure. Like the module used for the grate, the image also references a module but at a larger scale.

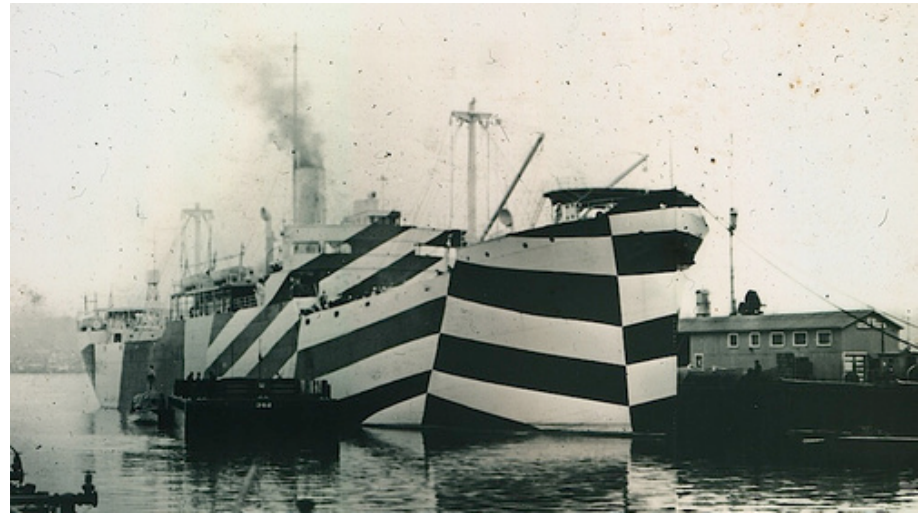

⁸Like the image of the ship, but implemented in a completely different way, the proposal aims to have the visual impact of something camouflaged. This will retain the current view of the island from land.

In the brief, the programs required include a dock, welcome pavilion, belvedere, place for views, and the re-imagining of the castle. While these programs touch on the social revitalization, additional environmental programs are proposed. A water treatment plant, as well as solar generator to keep the island off grid, are incorporated in the plans. The culmination of all these fundamentals composes the new Castle Pinckney and Shutes Folly Island.



SITE



DRY LAND

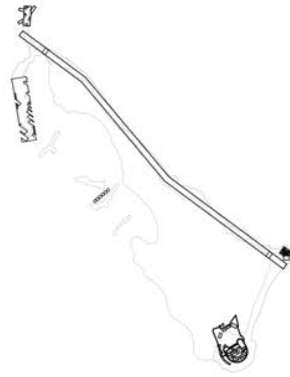

ADDED PROGRAM



COMPLETED NETWORK

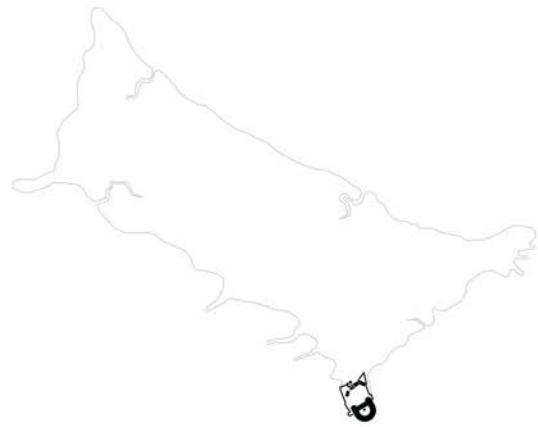

TIMELINE

1809



2013



PROPOSAL

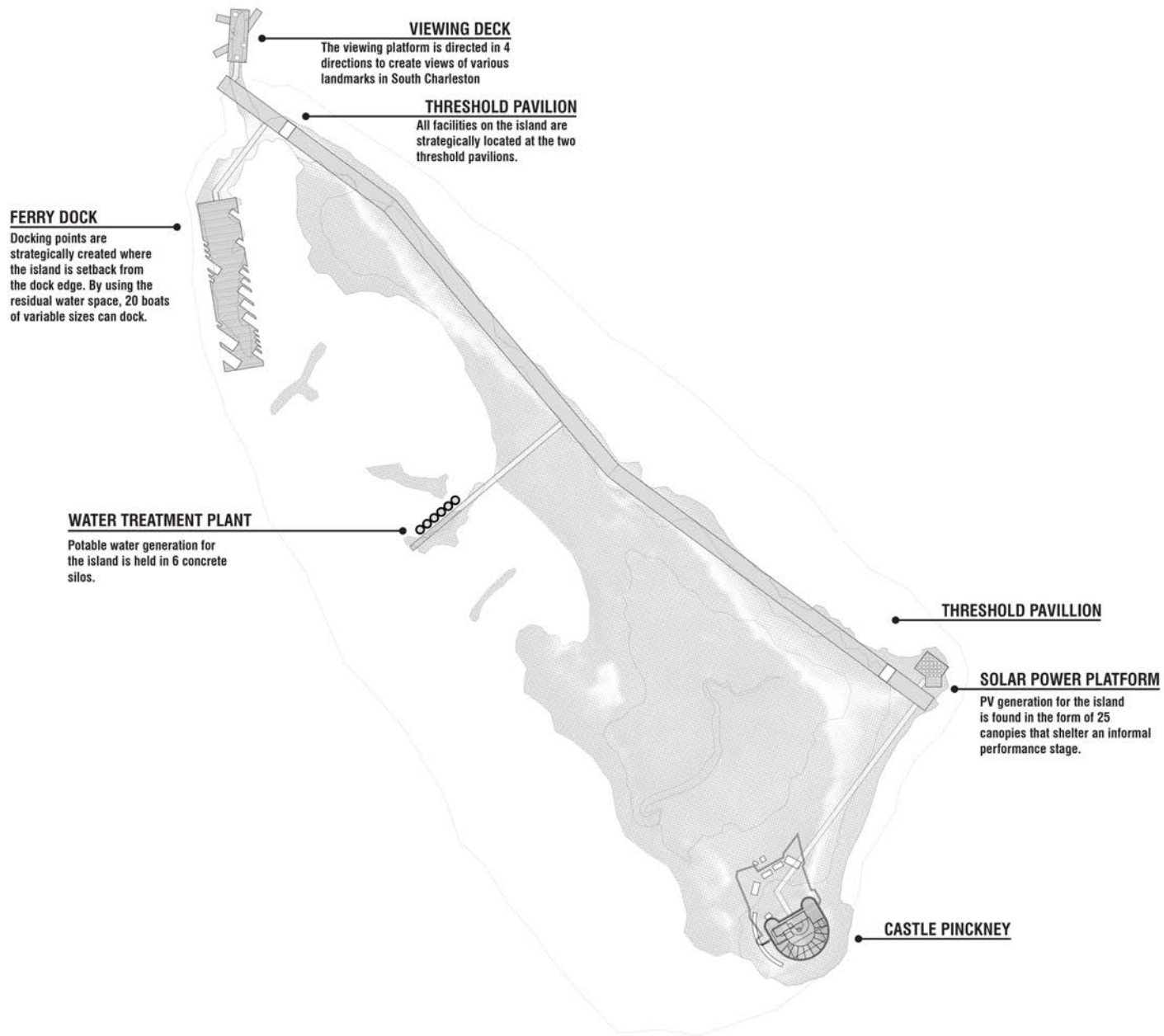

DESIGN PROPOSAL

MODULE

Located on the driest land of the island, a two-piece .5m x .5m modular steel grate is used throughout the project. This size is selected, as it offers the most flexibility. These dimensions allow it to be used singly as a seat, or when grouped in four or more, it forms a table. Various other configurations can easily be created by the user. The top piece of each grate is attached to a telescoping mechanism similar to a desk chair. The top module is capable of rising between 0 and 1.2m as desired by the user. Modules can be arranged into a specific formation for a specific use, or become completely self-driven by the users. The goal is to have areas arranged for specific uses such as auditorium seating beside people, creating arrangements for personal uses. In conclusion, a fully flexible and easy to use system becomes the primary fundamental element for our proposal.

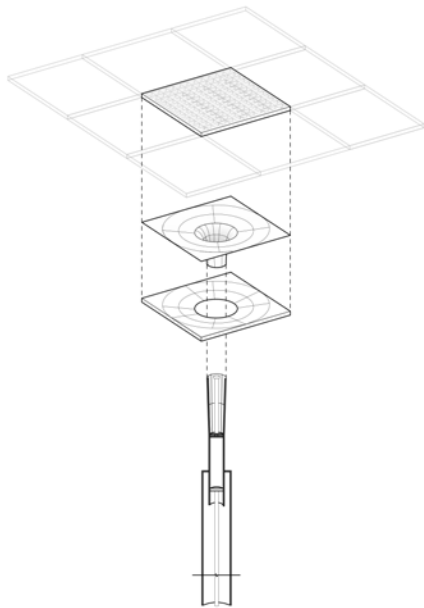

¹⁰Interstate Grating: Trench Banding

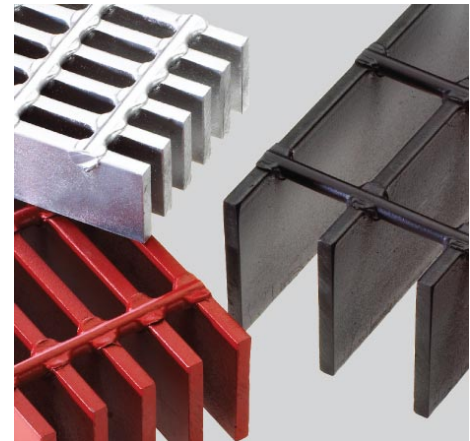

¹¹Interstate Grating: Heavy Duty Grate

SUPER BAR

The proposal is connected by a single spine, a raised pedestrian platform spanning from the north end to the south end of the island, the longest continuous span of dry land. This mega platform is referred to as the Super Bar. It can be programmatically compared to the core of the building, as everything connects to, and is supported by, this main infrastructure. Arranged from north to south, the following programs connect in a progressive order: viewing platform, dock, welcome pavilion, water treatment plant, pavilion, solar generation, and Castle Pinckney.

VIEWING PLATFORM

The deck itself acts, not only as a continuous viewing platform, but also as a dedicated viewing deck to direct views toward key monuments in Charleston. The area allows visitors to relax while taking in views of the Patriots Point Naval and Maritime Museum to the east, Liberty Square to the northwest, and the waterfront park to the southwest.



Viewing Platform

DOCK

As a new destination for the city of Charleston, a dock is erected to allow both the public ferry and private boats to dock temporarily. By providing a place for boats, the island's accessibility is greatly improved. Spaces for 20 boats including 2 ferries allow the island to accommodate transportation of enough people to successfully hold large events as an extension to those happening in the city.

WELCOME PAVILION

Two pavilions flank the ends of the Super Bar and act as the thresholds of the structure. They are the only permanent enclosures on the island, and are manifested in a framed form. The first pavilion contains information and a map of the island, and is angled to present a view of the castle Pinckney ruin across the island.



Welcome Pavilion



¹²Reference: Herzog de Meuron Schaulager

WATER TREATMENT

Water is collected and treated in 6 concrete silos located in a section of deep water next to the island. Enough water can be treated for the potable needs of the island's visitors and service requirements. This reduces the necessary transportation of water during peak season. A spin filter, 2 Stage system, and UV system is thus implemented to treat water.

SOLAR FIELD

The solar field is composed of 25 canopies that shelter an outdoor auditorium space. The 25 canopies are each 1m x 1m and generate 150000kwh/year. To generate the optimum solar collection, the canopies are oriented due south and angled at 30degrees. As a solar collector and shelter, the solar field becomes one of the most effective spaces during harsh weather.



Solar Field



¹³**Reference: Bike & electronics charging solar canopy**

SECOND PAVILION

Another pavilion is placed at the end of the Super Bar that acts identically to the welcome pavilion. Instead of framing a view to the Castle Pinckney ruin, the final pavilion is angled to a view of Patriots Point Naval and Maritime Museum across the water.

CASTLE

Castle Pinckney is a deteriorating historical landmark for Charleston. Without a glorious history, its historical presence is often overlooked. As an extension of the spine, the castle becomes another program attached to the Super Bar. In restoring the castle, the priority was to keep the existing earth in place. Its deteriorating state would require expensive excavation. Instead of revealing the castle below, steel grate is laid within, thus creating a platform. The entrance is then dug out to its former level, restoring the experience of the original arched threshold. To minimize disruption of the castle, the platform is placed at the same level as the top of the castle. By bringing visitors to this height, they will experience something similar to that of the soldiers. In reference to its history, outlines of the various changes made to the castle are overlaid and outlined in the steel grate. Additionally, outlines of various plans create extensions to the existing castle, which can be used as viewing platforms or fishing decks.



Castle Extension

1809- ORIGINAL PLAN

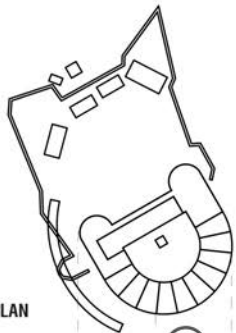

1833

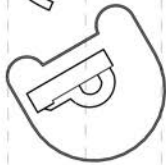

1888-1920

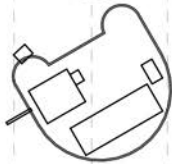

2013- PRESENT CASTLE WALLS

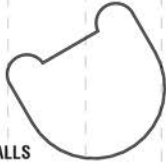

ALL PLANS OVERLAID

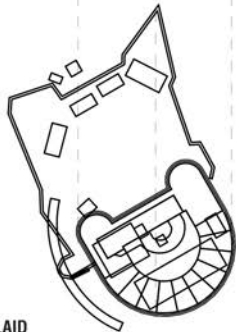

Castle Deck



Café Use



Art Exhibit

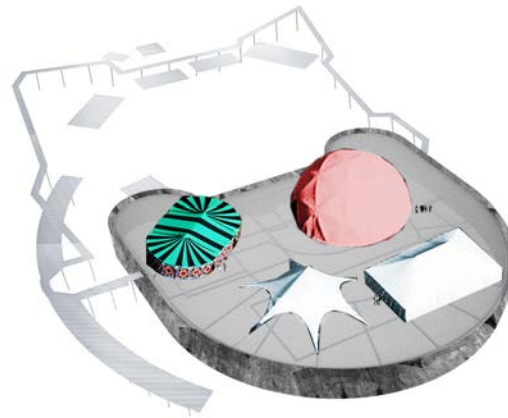

Fair

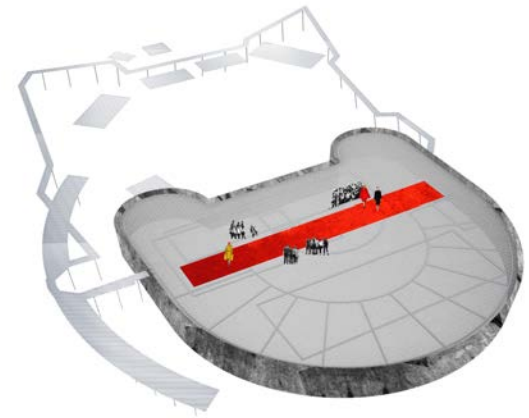

Runway

Event Use

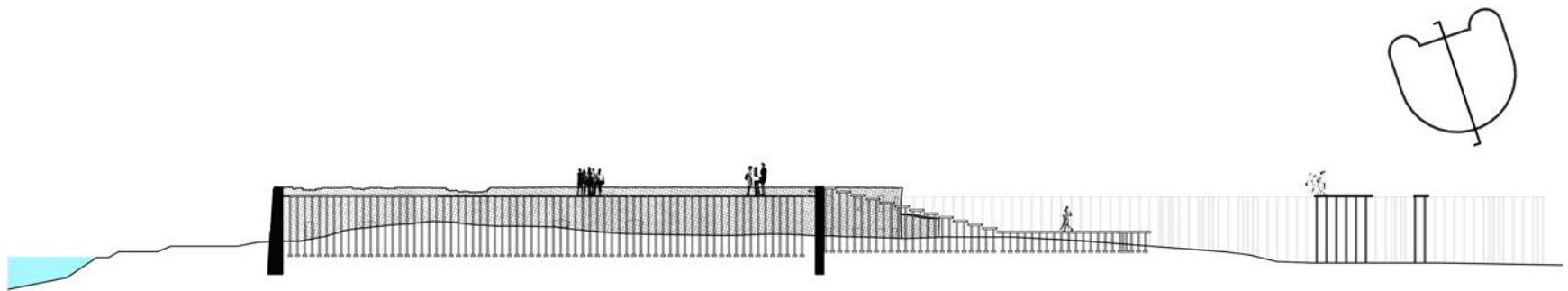

Site Section

¹ Harvard Graduate School of Design. "Precedent and Invention. Between History and Tradition: Notes Toward a Theory of Precedent." *The Harvard Architecture Review* 5: Precedent & Invention (1986): 192.

² Harvard Graduate School of Design. "Precedent and Invention. Between History and Tradition: Notes Toward a Theory of Precedent." *The Harvard Architecture Review* 5: Precedent & Invention (1986): 192.

³ "Rem Koolhaas reveals title for Venice Architecture Biennale 2014." Dezeen - architecture and design magazine. <http://www.dezeen.com/2013/01/25/rem-koolhaas-reveals-title-for-venice-architecture-biennale-2014/> (accessed August 22, 2013).

⁴ "2012-13 Preservation as Provocation." ACSA Home. <http://www.acsa-arch.org/programs-events/competitions/2012-13-preservation-as-provocation> (accessed August 23, 2013).

⁵ Rotor. "rotor." rotor. http://rotordb.org/project/2012_Grindbakken_expo (accessed August 22, 2013).

⁶ Murphy, Amy. "Seattle Central Library: Civic Architecture in the Age of Media: Places: Design Observer." Places: Design Observer. <http://places.designobserver.com/feature/seattle-central-library-civic-architecture-in-the-age-of-media/813/> (accessed August 22, 2013).

⁷ Borgman, Anna, and Candy Lenk. "LUFTSCHLOSS | TRIANGULATION BLOG." TRIANGULATION BLOG. <http://www.triangulationblog.com/2012/06/luftschloss.html> (accessed August 22, 2013).

⁸ "Dazzle Ships | The Public Domain Review." The Public Domain Review | Online journal dedicated to showcasing the most interesting and unusual out-of-copyright works available on the web. <http://publicdomainreview.org/2012/04/19/dazzle-ships/> (accessed August 22, 2013).

⁹ Simpson, Adam. "www.adsimpson.com." www.adsimpson.com. <http://www.adsimpson.com/Boundaries> (accessed August 22, 2013).

¹⁰ "Interstate Grating: Steel Grating." Interstate Grating: Bar Grating, Metal Grating, Metal Bar Grating. <http://www.interstategratings.com/steel-grating/steel-grating.php> (accessed August 23, 2013).

¹¹ "Interstate Grating: Steel Grating." Interstate Grating: Bar Grating, Metal Grating, Metal Bar Grating. <http://www.interstategratings.com/steel-grating/steel-grating.php> (accessed August 23, 2013).

¹¹ "Netherlands Architecture Institute - Item - 169 Schaulager Laurenz-Stiftung." Netherlands Architecture Institute. http://en.nai.nl/museum/exhibitions/online/herzog_de_meuron/item/_pid/kolom2-1/_rp_kolom2-1_elementId/1_163181 (accessed August 23, 2013).

¹² Kelley, Alex. "Heat Tab in the Sky: November 2011." Heat Tab in the Sky. http://heattab.blogspot.ca/2011_11_01_archive.html (accessed August 23, 2013).

BIBLIOGRAPHY

"2012-13 Preservation as Provocation." ACSA Home. <http://www.acsa-arch.org/programs-events/competitions/2012-13-preservation-as-provocation> (accessed August 23, 2013).

Borgman, Anna, and Candy Lenk. "LUFTSCHLOSS | TRIANGULATION BLOG." TRIANGULATION BLOG. <http://www.triangulationblog.com/2012/06/luftschloss.html> (accessed August 22, 2013).

"Dazzle Ships | The Public Domain Review." The Public Domain Review | Online journal dedicated to showcasing the most interesting and unusual out-of-copyright works available on the web. <http://publicdomainreview.org/2012/04/19/dazzle-ships/> (accessed August 22, 2013).

Harvard Graduate, School of Design. "Precedent and Invention. Between History and Tradition: Notes Toward a Theory of Precedent." *The Harvard Architecture Review* 5: Precedent & Invention (1986): 192.

"Interstate Grating: Steel Grating." Interstate Grating: Bar Grating, Metal Grating, Metal Bar Grating. <http://www.interstategratings.com/steel-grating/steel-grating.php> (accessed August 23, 2013).

Kelley, Alex. "Heat Tab in the Sky: November 2011." Heat Tab in the Sky. http://heattab.blogspot.ca/2011_11_01_archive.html (accessed August 23, 2013).

Murphy, Amy. "Seattle Central Library: Civic Architecture in the Age of Media: Places: Design Observer." Places: Design Observer. <http://places.designobserver.com/feature/seattle-central-library-civic-architecture-in-the-age-of-media/813/> (accessed August 22, 2013).

"Netherlands Architecture Institute - Item - 169 Schaulager Laurenz-Stiftung." Netherlands Architecture Institute. http://en.nai.nl/museum/exhibitions/online/herzog_de_meuron/item/_pid/kolom2-1/_rp_kolom2-1_elementId/1_163181 (accessed August 23, 2013).

"Rem Koolhaas reveals title for Venice Architecture Biennale 2014." Dezeen - architecture and design magazine. <http://www.dezeen.com/2013/01/25/rem-koolhaas-reveals-title-for-venice-architecture-biennale-2014/> (accessed August 22, 2013).

Rotor. "rotor." rotor. http://rotordb.org/project/2012_Grindbakken_expo (accessed August 22, 2013).

Simpson, Adam . "www.adsimpson.com." www.adsimpson.com. <http://www.adsimpson.com/Boundaries> (accessed August 22, 2013).